



## **reCool® for lathes**

Fast and easy retrofitting to internal cooling with oil and emulsion

[www.rego-fix.com](http://www.rego-fix.com)

**REGO-FIX** 



External flood cooling

Peripheral cooling

Internal cooling

The differences of wet and dry machining

# Supplying the right amount of coolant to where it matters

## Key features of external flood cooling

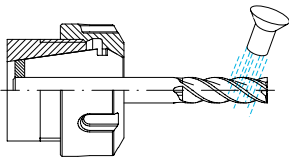

- // Universal application possibilities
- // Problems may arise with deep cavities
- // Reduction of tool life because cooling is not right on the cutting edge
- // Suboptimal chip deflection
- // Limited adjustment of nozzles due to different tool lengths and diameters

## Key features of peripheral cooling

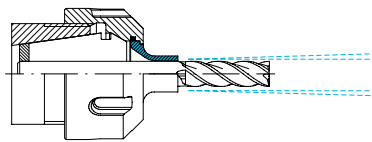

- // Achieve peripheral cooling with reCool® and the use of our coolant flush disk KS/ER
- // Coolant is fed along the side of the tool to the cutting edge
- // Can be used for moderate cavities

## Key features of internal cooling

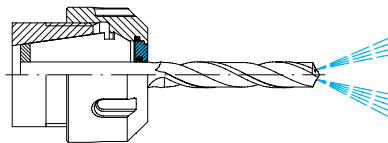

- // Achieve internal cooling with reCool® and the use of our sealing disk DS/ER
- // Precise cooling at the cutting edge and improved chip removal
- // Particularly suitable for deep cavities
- // Lubrication of cutting edge and cooling
- // Best surface quality

# Low-cost retrofitting to internal cooling

Retrofit flood cooling to internal cooling in two minutes with reCool®. Available for both static tooling systems and driven tools.

### Key features of reCool® static RCS for use with static holders

- // Cost-friendly conversion of existing static tooling systems to through coolant in only two minutes
- // For ER collets (DIN 6499 / ISO 15488) in stationary colletholders with external threads\*
- // Coolant pressures of up to 150 bar\*\*
- // RCS / ERMX for emulsion and oil coolants
- // Low-maintenance design
- // For coolant through tools (with sealing disks DS / ER) and for peripheral cooling (with coolant flush disks KS / ER)

\* reCool® static can also be used for internal threading with the corresponding adapter.

\*\* With high-pressure hoses RHS-HP. 100 bar with standard hose.

### Key features of reCool® rotary RCR for use with spindles

- // Cost-friendly conversion of existing driven tooling systems to through coolant in only two minutes
- // For ER and ERM thread in driven tools and turning machines and for ER collets to DIN 6499 / ISO 15488
- // Speeds up to 12,000 rpm\*
- // Coolant pressures up to 150 bar with high-pressure hose, standard hose max. 100 bar
- // Low-maintenance coolant lubricated bearings
- // For coolant through tools (with sealing disks DS / ER) and for peripheral cooling (with coolant flush disks KS / ER)
- // RCR / ER(M) for emulsion and oil coolants
- // Convert inner-threaded driven tools to outer-threaded, using the reCool® adapter. Thus, successfully prepare different types of driven tooling for the use of reCool®
- // Not for use with sealed collets DM

\* 6,000 rpm with RCR / ER 40. Higher speeds on request.

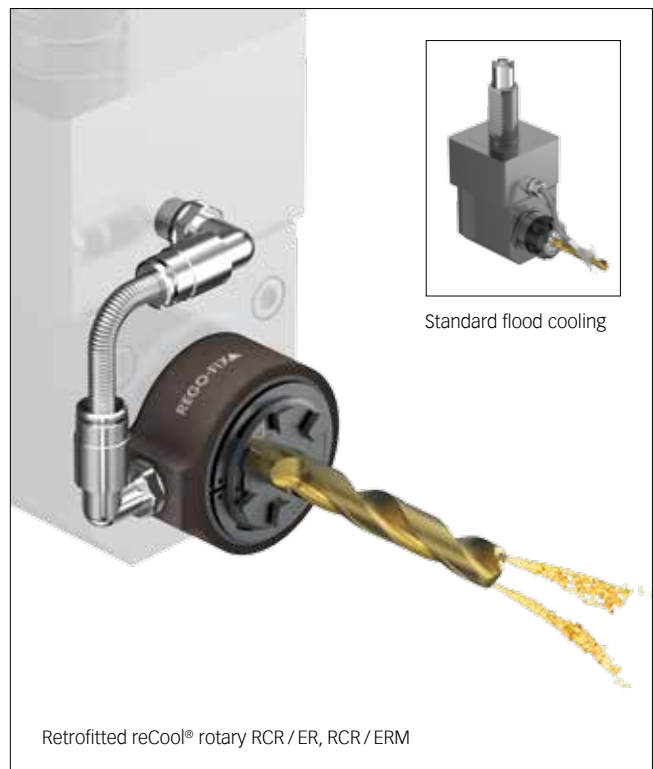

### Advantages of internal cooling with reCool®

- // Optimized coolant supply to the cutting edge: increases tool life and reduces cycle time
- // Best chip removal
- // No scattering or spray losses

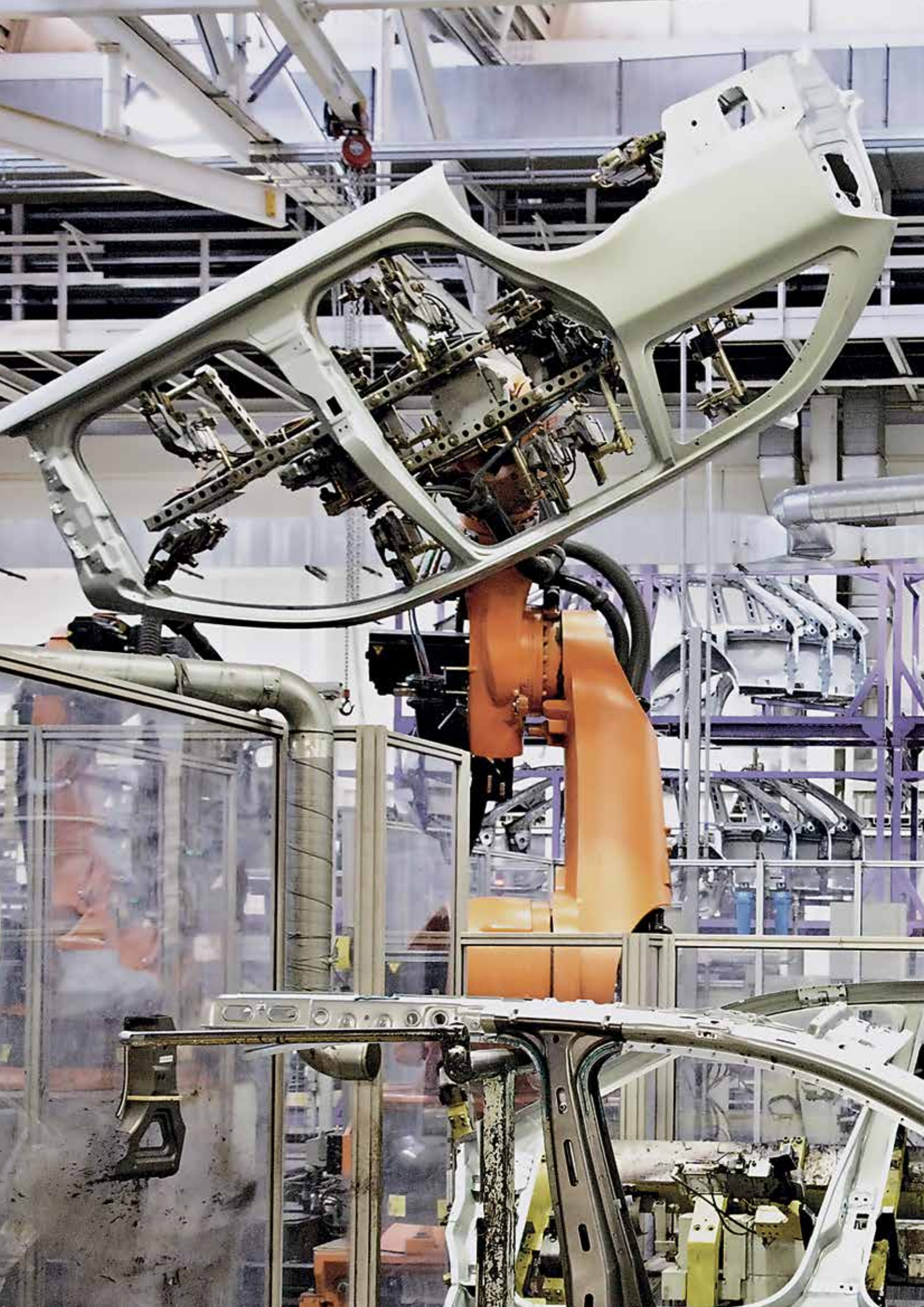

# reCool® gets you more for less

Achieve operational excellence by reducing manufacturing time and securing production chains.

## Customer 1

Production of metal tubes for air-conditioning sensors

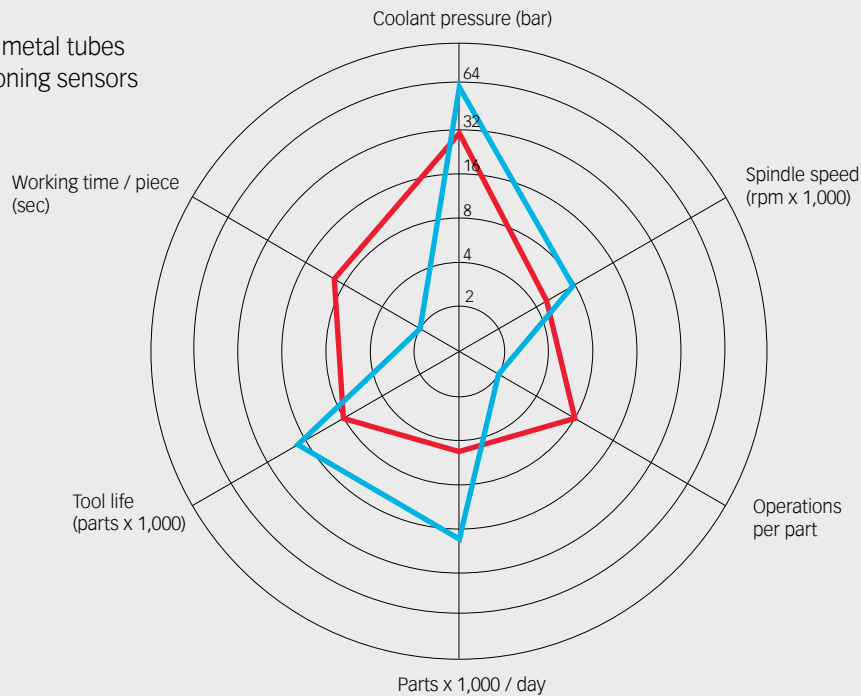

- // Parts per day up by 325%
- // Time per piece down by 77%
- // Operations per part down by 75%



Logarithmic scale

— conventional  
— with reCool®

**Automotive industry** Automotive manufacturers and suppliers are confronted with increasing process complexity, shorter technology cycles and steady pressure to innovate.

**Benefits of reCool®** reCool® enables customers to produce high-quality parts in less time with lowered costs. Our cooling solution is retrofittable on any turning machines and lathes. This is why reCool® offers great potential for almost all manufacturers.

Productivity is key for customers in the automotive industry. With beaming eyes, we tell you that our customer doubled his productivity thanks to reCool®.

Our products generate competitive advantages

# Bring coolant to where it matters

Reduce coolant quantity by retrofitting from flood cooling to internal or peripheral cooling.

## Customer 2

Production of hydraulic cylinders

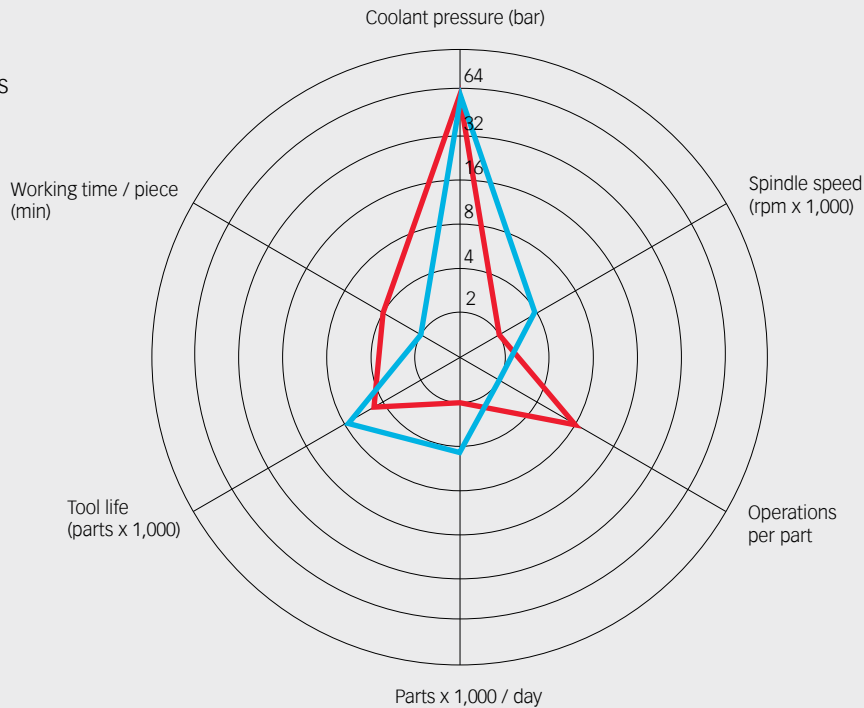

- // Working time down by 50 %
- // Spindle speed up by 100 %
- // Operations per part down by 75 %



Logarithmic scale

— conventional  
— with reCool®

## Interview



**Alan Fastner**

Product manager for reCool®

### What is the biggest benefit for customers when retrofitting from external cooling to internal cooling with reCool®?

Alan Fastner: For customer 3, we could increase the coolant pressure

by 55 bar. This leads to perfect cooling of the cutting edges and improved chip removal too.

### For which customers could reCool® be particularly interesting?

AF: For all customers that have turning and Swiss machines. Even modern machines often do not come with adequate cooling solutions.

### How are the initial costs of reCool® legitimized, considering the investment costs for a new production machine?

AF: A complete reCool® retrofitting of an entire machine costs only a

fraction of the price of machines with internal cooling.

### Taking into account modern production trends like 3D printing, how are the market developments for turning and reCool® in particular?

AF: Turning applications will remain an integral part of manufacturing, as production costs per part are extremely low. With a focus on high-tensile materials, that need lubrication and cooling while machining, reCool® provides a crucial benefit.

**Customer 3**

Production of contacting blocks for the power-electronics industry

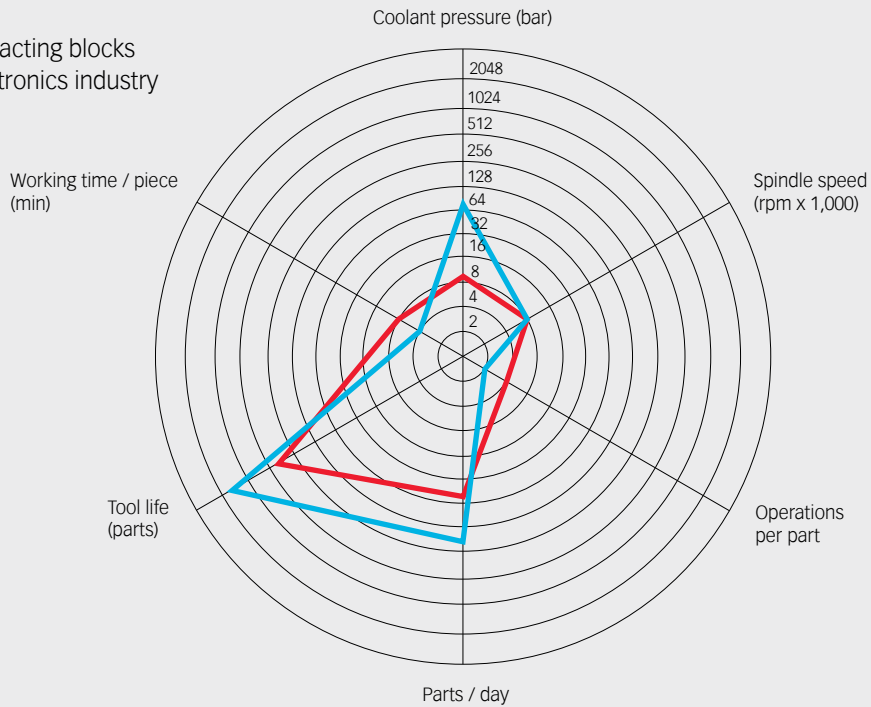

- // Pressure up by 700%
- // Parts per day up by 300%
- // Tool life up by 275%



Logarithmic scale

— conventional  
— with reCool®

Reduction of machine downtime is a major goal in production simply because downtime means loss of profit. Internal cooling with reCool® increases your tool life. Thus, effectively reducing not only tool costs but also downtime.

REGO-FIX supports manufacturers with insightful products

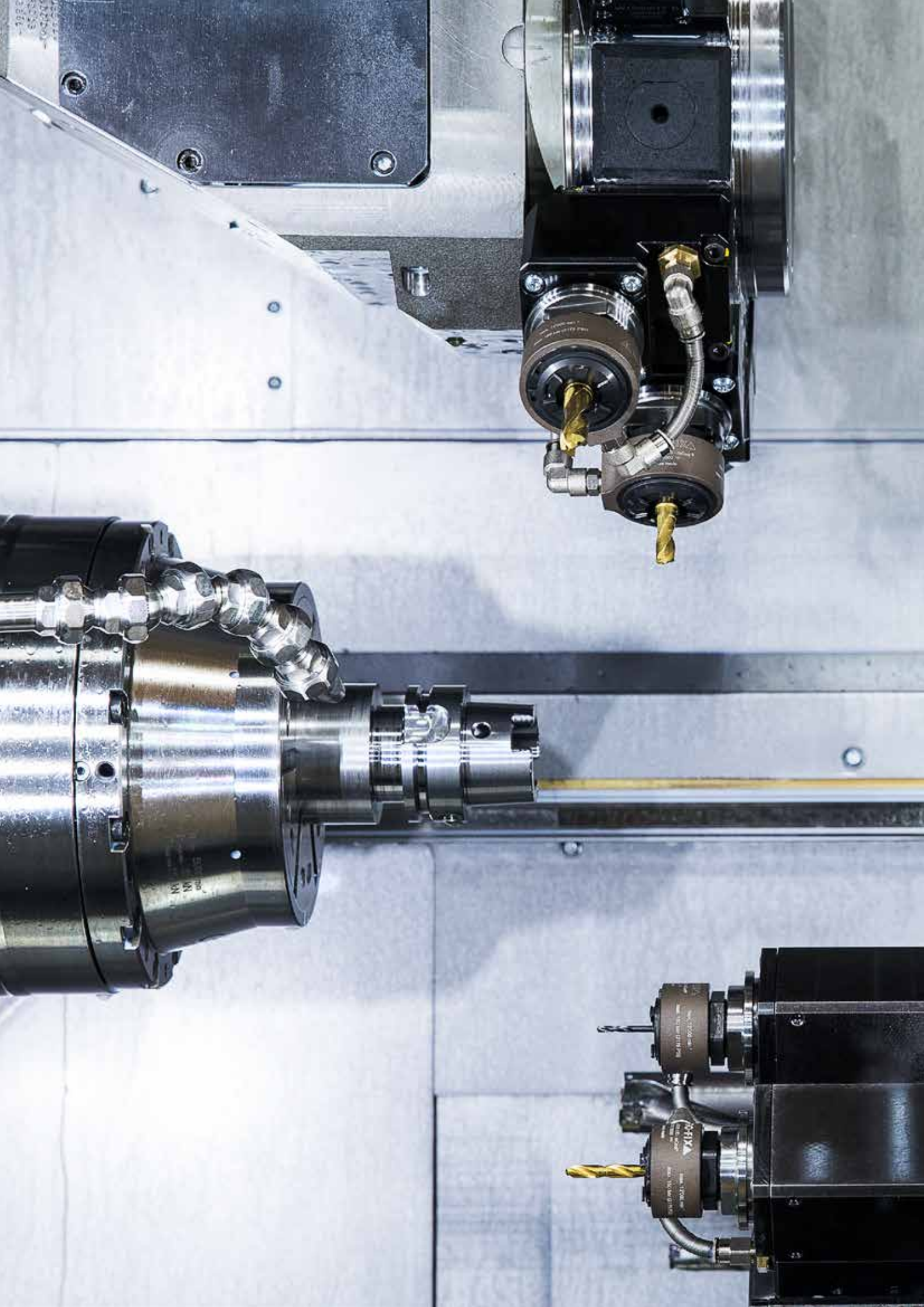



# Perfectly prepared for everything

Contract manufacturer, machine builder, and system constructor Sumec AG, headquartered in Niederbipp, Switzerland, recently retrofitted its machining centers with REGO-FIX's reCool® coolant-through lubrication system.

To be able to have competitive and profitable production operations in an expensive location such as Switzerland, manufacturing experts keep investing in modern technology as can be seen in the features being added to CNC machining centers. The goal was making a difficult part on a CNC machining center in a single pass to have short lead times and maximize the corresponding efficiency. This was tricky as drilling depths of up to ten times the diameter of the drill is only possible with tools that supply cutting fluid through internal cooling channels. To achieve this, the CNC machining centers must feature equipment for delivering the cutting fluid through the toolholder at the relevant driven turret stations. Installing the corresponding units and toolholders is not cheap.

Philipp Nützi, who is responsible for the CNC Production Engineering Unit at Sumec AG, reports:

**"We are now able to fully machine components, even complex ones, in a single pass in most cases. This has resulted in shorter lead times and greater flexibility – particularly when manufacturing single components and small batch sizes."**

#### Retrofitting coolant-through lubrication in a cost-effective manner

This is why they decided to retrofit a CNC machining center with the REGO-FIX reCool® cooling system at several driven stations instead. The system has several important advantages. Alan Fastner, product manager at REGO-FIX, explains that the special collet chucks consist of two components: the housing, that does not rotate, and the clamping nut, that does. The entire system is simply used to replace a standard clamping nut, and the cutting fluid is supplied from the outside. Once supplied, the fluid reaches the cooling channels in the clamped drilling and milling tools inside the reCool® system's clamping nuts. The reCool® system is characterized by a long service life and extremely low maintenance requirements.

reCool® is available for collet sizes of ER 11 to ER 40. It works with unparalleled reliability at speeds of up to 12,000 rpm, and makes it possible to deliver oils and emulsions at a pressure of up to 150 bar through the clamping nut into tools with internal cooling channels. Finally, all tools with a straight shank can be inserted and clamped just like in a standard collet chuck.

**Flexibility as a result of fast and easy setup** In addition, the experts in Niederbipp have been able to maintain a high level of flexibility that enables them to use or forego cutting fluid as necessary, all thanks to the fact that the reCool® system can be set up and removed in record time.

**Various options that expand the range of applications** One of the options with reCool® is to use a coolant flush disk instead of a sealing disk. When this option is used, the supplied cutting fluid will not go into the internal cooling channels of the tool that is clamped, but instead will reach the cutting edge of the drilling and milling tools from outside, via the shank. When compared to the standard lubrication supply systems like a modular hose system, reCool® allows a much better and more targeted cooling supply.

The reCool® is also available for driven tools with internal threads, further enhancing the system's versatility.

Originally reCool® was purchased for machining eccentric axial holes to be made. Sumec made very good experiences with the system so that Philipp Nützi concludes:

**"That's why we will definitely keep using reCool® in the future for machining when coolant through tools are used."**



Discover the reCool® universe

# Maximum cooling possibilities

reCool® is made for static and rotary applications and offers cooling possibilities for peripheral and internal cooling, while making best use of your existing toolholding equipment.

Recommended torque wrench



TORCO-FIX for reCool® RCS and reCool® RCR

Matching wrenches and wrench heads



E MX for reCool® RCS



E AX for reCool® RCR



reCool® RCS for static applications



reCool® RCR for rotary applications

Peripheral cooling

Internal cooling



Coolant flush disk KS / ER



Sealing disk DS / ER

Standard ER or ER-UP collet

Standard ER and ER mini cylindrical toolholders or driven tools

# reCool® RCS

Type	Part no.	Dimensions [mm]		Thread	Accessory	Included in set RCS	
		B	D		Wrench	Type	Qty.
<b>Set RCS (for emulsion- and oil-based coolants)</b>							
SET RCS / ERMX 16	3716.50000	22.5	27.5	M 19 x 1	E 16 MX	RCS/ERMX 16/20	1
SET RCS / ERMX 20	3720.50000	24	34.5	M 24 x 1	E 20 MX	SET RHS-100	1
						SET RVG-100 1/8" - 0°	2
						SET RVA-100 1/8" - 90°	2
<b>RCS/ERMX nut (for emulsion- and oil-based coolants)</b>							
RCS / ERMX 16	3716.59000	22.5	27.5	M 19 x 1	E 16 MX		
RCS / ERMX 20	3720.59000	24	34.5	M 24 x 1	E 20 MX		

Accessories are not included in delivery.

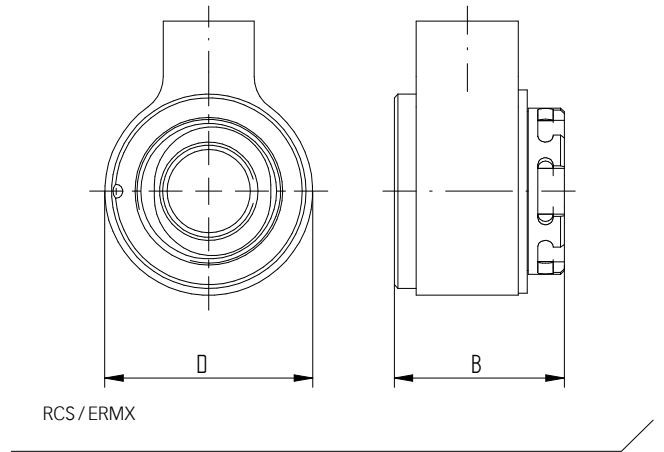

## reCool® sets overview

# reCool® RCS and reCool® RCR sets

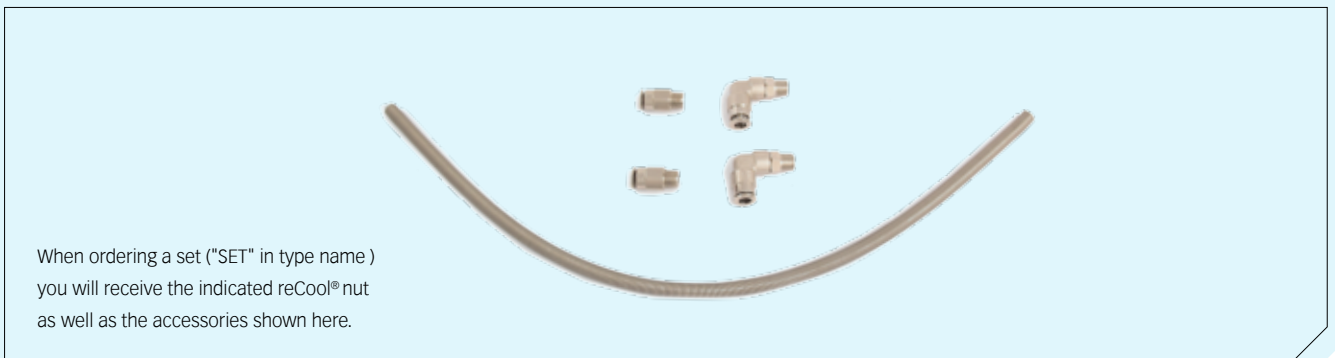

# reCool® RCR

Type	Part no.	Dimensions [mm]		Thread	Accessory	Included in set RCR/ER	
		B	D		Wrench	Type	Qty.
<b>Set RCR-E&amp;O / ER (for emulsion- and oil-based coolants)</b>							
SET RCR-E&O / ER 11	3711.10000	16.6	21.75	M 14 x 0.75	E 11 AX	RCR / ER 11 – 40	1
SET RCR-E&O / ER 16	3716.10000	24.5	34	M 22 x 1.5	E 16 AX	SET RHS-100	1
SET RCR-E&O / ER 20	3720.10000	26	40	M 25 x 1.5	E 20 AX	SET RVG-100 1/8"–0°	2
SET RCR-E&O / ER 25	3725.10000	27	50	M 32 x 1.5	E 25 AX	SET RVA-100 1/8"–90°	2
SET RCR-E&O / ER 32	3732.10000	29.5	62.5	M 40 x 1.5	E 32 AX		
SET RCR-E&O / ER 40	3740.10000	32.5	72.5	M 50 x 1.5	E 40 AX		

See page 12 for contents.

Type	Part no.	Dimensions [mm]		Thread	Accessory
		B	D		Wrench
<b>RCR-E&amp;O / ER nut (for emulsion- and oil-based coolants)</b>					
RCR-E&O / ER 11	3711.19000	16.6	21.75	M 14 x 0.75	E 11 AX
RCR-E&O / ER 16	3716.19000	24.5	34	M 22 x 1.5	E 16 AX
RCR-E&O / ER 20	3720.19000	26	40	M 25 x 1.5	E 20 AX
RCR-E&O / ER 25	3725.19000	27	50	M 32 x 1.5	E 25 AX
RCR-E&O / ER 32	3732.19000	29.5	62.5	M 40 x 1.5	E 32 AX
RCR-E&O / ER 40	3740.19000	32.5	72.5	M 50 x 1.5	E 40 AX

Accessories are not included in delivery.

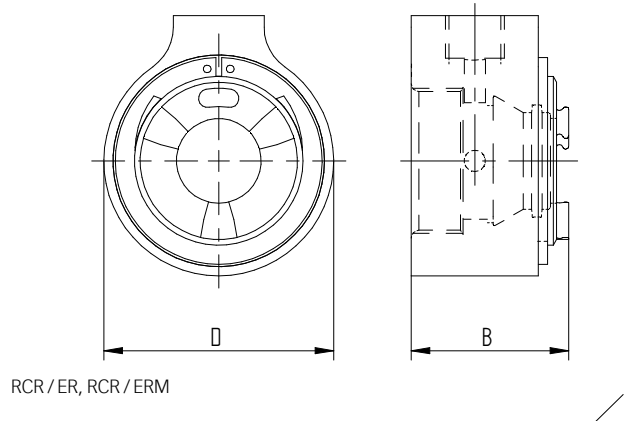

Type	Part no.	Dimensions [mm]		Thread	Accessory	Included in set RCR/ERM	
		B	D		Wrench	Type	Qty.
<b>Set RCR / ERM (for emulsion- and oil-based coolants)</b>							
SET RCR / ERM 11	3711.30000	16.6	21.75	M 13 x 0.75	E 11 AX	RCR / ERM 11 – 25	1
SET RCR / ERM 16	3716.30000	24.5	31	M 19 x 1	E 16 AX	SET RHS-100	1
SET RCR / ERM 20	3720.30000	26	38	M 24 x 1	E 20 AX	SET RVG-100 1/8"–0°	2
SET RCR / ERM 25	3725.30000	27	46	M 30 x 1	E 25 AX	SET RVA-100 1/8"–90°	2

See page 12 for contents.

Type	Part no.	Dimensions [mm]		Thread	Accessory
		B	D		Wrench
<b>RCR / ERM nut (for emulsion- and oil-based coolants)</b>					
RCR / ERM 11	3711.39000	16.6	21.75	M 13 x 0.75	E 11 AX
RCR / ERM 16	3716.39000	24.5	31	M 19 x 1	E 16 AX
RCR / ERM 20	3720.39000	26	38	M 24 x 1	E 20 AX
RCR / ERM 25	3725.39000	27	46	M 30 x 1	E 25 AX

Accessories are not included in delivery.

## Coolant flush disks KS / ER

Compatible with reCool® RCS and RCR for peripheral cooling

Type	Part no.	Ø [mm]
<b>KS / ER 16</b>		
Ø 3.0 mm	3916.20300	3
Ø 4.0 mm	3916.20400	4
Ø 5.0 mm	3916.20500	5
Ø 6.0 mm	3916.20600	6
Ø 7.0 mm	3916.20700	7
Ø 8.0 mm	3916.20800	8
Ø 9.0 mm	3916.20900	9
Ø 10.0 mm	3916.21000	10
BLANK KS / ER 16 Ø 11 x 12*	3916.29999	–
<b>KS / ER 20</b>		
Ø 3.0 mm	3920.20300	3
Ø 4.0 mm	3920.20400	4
Ø 5.0 mm	3920.20500	5
Ø 6.0 mm	3920.20600	6
Ø 7.0 mm	3920.20700	7
Ø 8.0 mm	3920.20800	8
Ø 9.0 mm	3920.20900	9
Ø 10.0 mm	3920.21000	10
Ø 12.0 mm	3920.21200	12
BLANK KS / ER 20 Ø 14 x 12*	3920.29999	–
<b>KS / ER 25</b>		
Ø 3.0 mm	3925.20300	3
Ø 4.0 mm	3925.20400	4
Ø 5.0 mm	3925.20500	5
Ø 6.0 mm	3925.20600	6
Ø 7.0 mm	3925.20700	7
Ø 8.0 mm	3925.20800	8
Ø 9.0 mm	3925.20900	9
Ø 10.0 mm	3925.21000	10
Ø 12.0 mm	3925.21200	12
Ø 14.0 mm	3925.21400	14
Ø 16.0 mm	3925.21600	16
BLANK KS / ER 25 Ø 19 x 12*	3925.29999	–

Type	Part no.	Ø [mm]
<b>KS / ER 32</b>		
Ø 3.0 mm	3932.20300	3
Ø 4.0 mm	3932.20400	4
Ø 5.0 mm	3932.20500	5
Ø 6.0 mm	3932.20600	6
Ø 7.0 mm	3932.20700	7
Ø 8.0 mm	3932.20800	8
Ø 9.0 mm	3932.20900	9
Ø 10.0 mm	3932.21000	10
Ø 12.0 mm	3932.21200	12
Ø 14.0 mm	3932.21400	14
Ø 16.0 mm	3932.21600	16
Ø 18.0 mm	3932.21800	18
Ø 20.0 mm	3932.22000	20
BLANK KS / ER 32 Ø 24 x 12*	3932.29999	–

\* Work material: 42CrMoS4 (1.7227).



## Sealing disks DS / ER

Compatible with reCool® RCS and RCR for internal cooling

Type	Part no.	Bore Ø	
		[mm]	[inch]
<b>DS / ER 11</b>			
Ø 3.0 mm	3911.00300	3.0	–
Ø 1/8"	3911.00318	–	1/8
Ø 4.0 mm / 5/32"	3911.00400	4.0	5/32
Ø 3/16"	3911.00476	–	3/16
Ø 5.0 mm	3911.00500	5.0	–
Ø 6.0 mm	3911.00600	6.0	–
Ø 1/4"	3911.00635	–	1/4

Type	Part no.	Bore Ø	
		[mm]	Incl. in set
<b>DS / ER 16</b>			
DS / ER 16 SET (14 pcs.)	3916.00000	3.0–10.0	–
Ø 3.0 mm	3916.00300	3.0–2.5	–
Ø 3.5 mm	3916.00350	3.5–3.0	•
Ø 4.0 mm	3916.00400	4.0–3.5	•
Ø 4.5 mm	3916.00450	4.5–4.0	•
Ø 5.0 mm	3916.00500	5.0–4.5	•
Ø 5.5 mm	3916.00550	5.5–5.0	•
Ø 6.0 mm	3916.00600	6.0–5.5	•
Ø 6.5 mm	3916.00650	6.5–6.0	•
Ø 7.0 mm	3916.00700	7.0–6.5	•
Ø 7.5 mm	3916.00750	7.5–7.0	•
Ø 8.0 mm	3916.00800	8.0–7.5	•
Ø 8.5 mm	3916.00850	8.5–8.0	•
Ø 9.0 mm	3916.00900	9.0–8.5	•
Ø 9.5 mm	3916.00950	9.5–9.0	•
Ø 10.0 mm	3916.01000	10.0–9.5	•

Type	Part no.	Bore Ø	
		[mm]	Incl. in set
<b>DS / ER 20</b>			
SET DS / ER 20 (20 pcs.)	3920.00000	3.0–13.0	–
Ø 3.0 mm	3920.00300	3.0–2.5	–
Ø 3.5 mm	3920.00350	3.5–3.0	•
Ø 4.0 mm	3920.00400	4.0–3.5	•
Ø 4.5 mm	3920.00450	4.5–4.0	•
Ø 5.0 mm	3920.00500	5.0–4.5	•
Ø 5.5 mm	3920.00550	5.5–5.0	•
Ø 6.0 mm	3920.00600	6.0–5.5	•
Ø 6.5 mm	3920.00650	6.5–6.0	•
Ø 7.0 mm	3920.00700	7.0–6.5	•
Ø 7.5 mm	3920.00750	7.5–7.0	•
Ø 8.0 mm	3920.00800	8.0–7.5	•
Ø 8.5 mm	3920.00850	8.5–8.0	•
Ø 9.0 mm	3920.00900	9.0–8.5	•
Ø 9.5 mm	3920.00950	9.5–9.0	•
Ø 10.0 mm	3920.01000	10.0–9.5	•
Ø 10.5 mm	3920.01050	10.5–10.0	•
Ø 11.0 mm	3920.01100	11.0–10.5	•
Ø 11.5 mm	3920.01150	11.5–11.0	•
Ø 12.0 mm	3920.01200	12.0–11.5	•
Ø 12.5 mm	3920.01250	12,5–12,0	•
Ø 13.0 mm	3920.01300	13,0–12,5	•

Included in the DS/ER sets are all marked disks within that ER size and the matching disk tray DSR.

## Sealing disks DS / ER

Compatible with reCool® RCS and RCR for internal cooling

Type	Part no.	Bore Ø	
		[mm]	Incl. in set
<b>DS / ER 25</b>			
SET DS / ER 25 (26 pcs.)	3925.00000	3.0 – 16.0	–
Ø 3.0 mm	3925.00300	3.0 – 2.5	–
Ø 3.5 mm	3925.00350	3.5 – 3.0	•
Ø 4.0 mm	3925.00400	4.0 – 3.5	•
Ø 4.5 mm	3925.00450	4.5 – 4.0	•
Ø 5.0 mm	3925.00500	5.0 – 4.5	•
Ø 5.5 mm	3925.00550	5.5 – 5.0	•
Ø 6.0 mm	3925.00600	6.0 – 5.5	•
Ø 6.5 mm	3925.00650	6.5 – 6.0	•
Ø 7.0 mm	3925.00700	7.0 – 6.5	•
Ø 7.5 mm	3925.00750	7.5 – 7.0	•
Ø 8.0 mm	3925.00800	8.0 – 7.5	•
Ø 8.5 mm	3925.00850	8.5 – 8.0	•
Ø 9.0 mm	3925.00900	9.0 – 8.5	•
Ø 9.5 mm	3925.00950	9.5 – 9.0	•
Ø 10.0 mm	3925.01000	10.0 – 9.5	•
Ø 10.5 mm	3925.01050	10.5 – 10.0	•
Ø 11.0 mm	3925.01100	11.0 – 10.5	•
Ø 11.5 mm	3925.01150	11.5 – 11.0	•
Ø 12.0 mm	3925.01200	12.0 – 11.5	•
Ø 12.5 mm	3925.01250	12.5 – 12.0	•
Ø 13.0 mm	3925.01300	13.0 – 12.5	•
Ø 13.5 mm	3925.01350	13.5 – 13.0	•
Ø 14.0 mm	3925.01400	14.0 – 13.5	•
Ø 14.5 mm	3925.01450	14.5 – 14.0	•
Ø 15.0 mm	3925.01500	15.0 – 14.5	•
Ø 15.5 mm	3925.01550	15.5 – 15.0	•
Ø 16.0 mm	3925.01600	16.0 – 15.5	•

Type	Part no.	Bore Ø	
		[mm]	Incl. in set
<b>DS / ER 32</b>			
DS / ER 32 SET (34 pcs.)	3932.00000	3.0 – 20.0	–
Ø 3.0 mm	3932.00300	3.0 – 2.5	–
Ø 3.5 mm	3932.00350	3.5 – 3.0	•
Ø 4.0 mm	3932.00400	4.0 – 3.5	•
Ø 4.5 mm	3932.00450	4.5 – 4.0	•
Ø 5.0 mm	3932.00500	5.0 – 4.5	•
Ø 5.5 mm	3932.00550	5.5 – 5.0	•
Ø 6.0 mm	3932.00600	6.0 – 5.5	•
Ø 6.5 mm	3932.00650	6.5 – 6.0	•
Ø 7.0 mm	3932.00700	7.0 – 6.5	•
Ø 7.5 mm	3932.00750	7.5 – 7.0	•
Ø 8.0 mm	3932.00800	8.0 – 7.5	•
Ø 8.5 mm	3932.00850	8.5 – 8.0	•
Ø 9.0 mm	3932.00900	9.0 – 8.5	•
Ø 9.5 mm	3932.00950	9.5 – 9.0	•
Ø 10.0 mm	3932.01000	10.0 – 9.5	•
Ø 10.5 mm	3932.01050	10.5 – 10.0	•
Ø 11.0 mm	3932.01100	11.0 – 10.5	•
Ø 11.5 mm	3932.01150	11.5 – 11.0	•
Ø 12.0 mm	3932.01200	12.0 – 11.5	•
Ø 12.5 mm	3932.01250	12.5 – 12.0	•
Ø 13.0 mm	3932.01300	13.0 – 12.5	•
Ø 13.5 mm	3932.01350	13.5 – 13.0	•
Ø 14.0 mm	3932.01400	14.0 – 13.5	•
Ø 14.5 mm	3932.01450	14.5 – 14.0	•
Ø 15.0 mm	3932.01500	15.0 – 14.5	•
Ø 15.5 mm	3932.01550	15.5 – 15.0	•
Ø 16.0 mm	3932.01600	16.0 – 15.5	•
Ø 16.5 mm	3932.01650	16.5 – 16.0	•
Ø 17.0 mm	3932.01700	17.0 – 16.5	•
Ø 17.5 mm	3932.01750	17.5 – 17.0	•
Ø 18.0 mm	3932.01800	18.0 – 17.5	•
Ø 18.5 mm	3932.01850	18.5 – 18.0	•
Ø 19.0 mm	3932.01900	19.0 – 18.5	•
Ø 19.5 mm	3932.01950	19.5 – 19.0	•
Ø 20.0 mm	3932.02000	20.0 – 19.5	•

Included in the DS/ER sets are all marked disks within that ER size and the matching disk tray DSR.



## Sealing disks DS / ER

Compatible with reCool® RCS and RCR for internal cooling

Type	Part no.	Bore Ø	
		[mm]	Incl. in set
<b>DS / ER 40</b>			
DS / ER 40 SET (46 pcs.)	3940.00000	3.0–26.0	–
Ø 3.0 mm	3940.00300	3.0–2.5	–
Ø 3.5 mm	3940.00350	3.5–3.0	•
Ø 4.0 mm	3940.00400	4.0–3.5	•
Ø 4.5 mm	3940.00450	4.5–4.0	•
Ø 5.0 mm	3940.00500	5.0–4.5	•
Ø 5.5 mm	3940.00550	5.5–5.0	•
Ø 6.0 mm	3940.00600	6.0–5.5	•
Ø 6.5 mm	3940.00650	6.5–6.0	•
Ø 7.0 mm	3940.00700	7.0–6.5	•
Ø 7.5 mm	3940.00750	7.5–7.0	•
Ø 8.0 mm	3940.00800	8.0–7.5	•
Ø 8.5 mm	3940.00850	8.5–8.0	•
Ø 9.0 mm	3940.00900	9.0–8.5	•
Ø 9.5 mm	3940.00950	9.5–9.0	•
Ø 10.0 mm	3940.01000	10.0–9.5	•
Ø 10.5 mm	3940.01050	10.5–10.0	•
Ø 11.0 mm	3940.01100	11.0–10.5	•
Ø 11.5 mm	3940.01150	11.5–11.0	•
Ø 12.0 mm	3940.01200	12.0–11.5	•
Ø 12.5 mm	3940.01250	12.5–12.0	•
Ø 13.0 mm	3940.01300	13.0–12.5	•
Ø 13.5 mm	3940.01350	13.5–13.0	•
Ø 14.0 mm	3940.01400	14.0–13.5	•
Ø 14.5 mm	3940.01450	14.5–14.0	•
Ø 15.0 mm	3940.01500	15.0–14.5	•
Ø 15.5 mm	3940.01550	15.5–15.0	•
Ø 16.0 mm	3940.01600	16.0–15.5	•
Ø 16.5 mm	3940.01650	16.5–16.0	•
Ø 17.0 mm	3940.01700	17.0–16.5	•
Ø 17.5 mm	3940.01750	17.5–17.0	•
Ø 18.0 mm	3940.01800	18.0–17.5	•
Ø 18.5 mm	3940.01850	18.5–18.0	•
Ø 19.0 mm	3940.01900	19.0–18.5	•
Ø 19.5 mm	3940.01950	19.5–19.0	•
Ø 20.0 mm	3940.02000	20.0–19.5	•
Ø 20.5 mm	3940.02050	20.5–20.0	•
Ø 21.0 mm	3940.02100	21.0–20.5	•

Type	Part no.	Bore Ø	
		[mm]	Incl. in set
Ø 21.5 mm	3940.02150	21.5–21.0	•
Ø 22.0 mm	3940.02200	22.0–21.5	•
Ø 22.5 mm	3940.02250	22.5–22.0	•
Ø 23.0 mm	3940.02300	23.0–22.5	•
Ø 23.5 mm	3940.02350	23.5–23.0	•
Ø 24.0 mm	3940.02400	24.0–23.5	•
Ø 24.5 mm	3940.02450	24.5–24.0	•
Ø 25.0 mm	3940.02500	25.0–24.5	•
Ø 25.5 mm	3940.02550	25.5–25.0	•
Ø 26.0 mm	3940.02600	26.0–25.5	•

Included in the DS/ER sets are all marked disks within that ER size and the matching disk tray DSR.

# reCool® accessories

Type	Part no.	Length [mm]
<b>High-pressure hoses (≤150 bar) with threaded 1/8" ends</b>		
SET RHS-HP L100	3799.97100	100
SET RHS-HP L200	3799.97200	200
SET RHS-HP L300	3799.97300	300
SET RHS-HP L400	3799.97400	400

<b>Standard hose set (≤100 bar)</b>		
SET RHS-100	3799.95000	–

<b>Fitting sets (2 pieces each)</b>		
SET RVG-100 1/8" –0°	3799.96180	–
SET RVA-100 1/8" –90°	3799.96189	–
SET RVG-100 M8 x 1–0°	3799.96810	–

Type	Part no.	Ø [mm]	Length [mm]
<b>Ball adapters RBA (1/8" BSP)</b>			
RBA 10	3799.93100	10	–
RBA 11	3799.93110	11	–
RBA 12	3799.93120	12	–
RBA 13	3799.93130	13	–
RBA 14	3799.93140	14	–
RBA 15	3799.93150	15	–
RBA 16	3799.93160	16	–

<b>Aluminum ring adapters RRA (1/8" BSP)</b>			
RRA 10	3799.94100	10	–
RRA 11	3799.94110	11	–
RRA 12	3799.94120	12	–
RRA 13	3799.94130	13	–
RRA 14	3799.94140	14	–
RRA 15	3799.94150	15	–
RRA 16	3799.94160	16	–

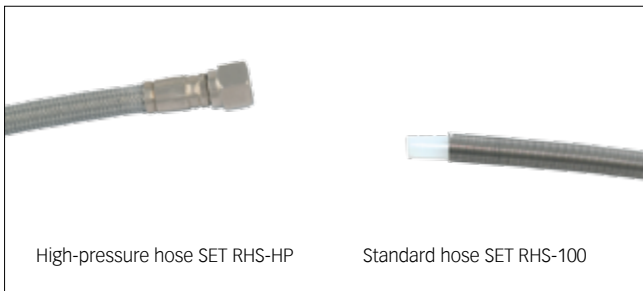

Expert advice

The ball adapter **RBA** is used when the driven tool has a ball connection. The fitting can then be used on the hose.

The aluminum ring adapter **RRA** can be used when the driven tool cooling connection uses the "press-in" principle.



# reCool® adapter and mounting accessories

**Internal thread** Colletholders and driven tools with internal thread are specially designed for smaller lathes and Swiss automatics that have limited space and many mounted tools.

Thanks to their shortness they possess a superior stiffness and do not protrude heavily from the tooling revolver. This shortest possible projection increases the axis of travel of the machine and allows larger workpieces to be machined.

**reCool® adapter** The reCool® adapter RC-ADP easily converts inner-threaded driven tools to outer-threaded version. This enables the use of the reCool® rotary coolant supply system RCR with different types of driven tooling.

**How to use?** Just screw the adapter with advised tightening torque into the driven tool, use the correctly installed reCool® connect the rotary coolant supply system and clamp the tool in the RCR.

Type	Part no.	Dimensions [mm]		Thread G1	Thread G2
		d	L		
<b>reCool® adapters</b>					
RC-ADP 16	3799.81600	16	8.7	M 24 x 1	M 22 x 1.5
RC-ADP 20	3799.82000	20	8.2	M 28 x 1.5	M 25 x 1.5
RC-ADP 25	3799.82500	25	7.9	M 32 x 1.5	M 32 x 1.5
RC-ADP 32	3799.83200	32	8.7	M 40 x 1.5	M 40 x 1.5
RC-ADP 40	3799.84000	40	9.6	M 50 x 1.5	M 50 x 1.5

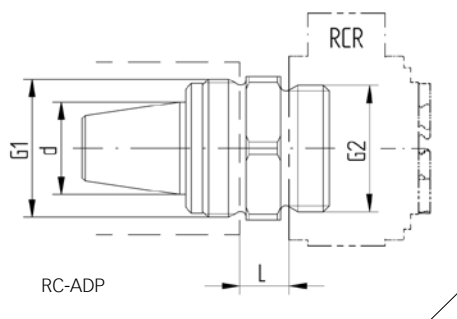

Type	Part no.	D [mm]	L [mm]
<b>Assembly tool for sealing discs DS/ER 11</b>			
MWZ 11	3911.88888	12	140

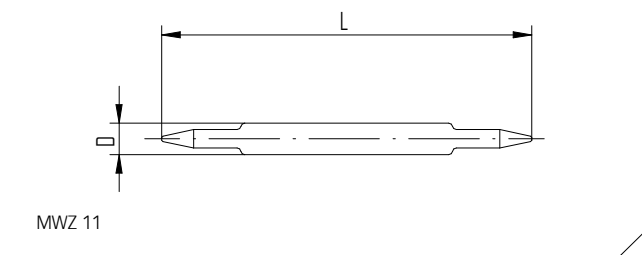

# reCool® wrenches

Type	Part no.	A [mm]	B [mm]
<b>E AX wrenches</b>			
E 11 AX	7117.11000	16.5	108
E 16 AX	7117.16000	22	131
E 20 AX	7117.20000	26	148
E 25 AX	7117.25000	30	165
E 32 AX	7117.32000	37	196
E 40 AX	7117.40000	47	220

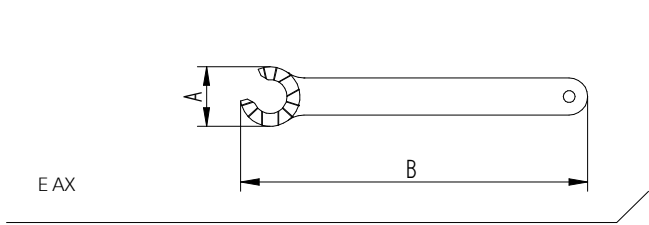

Type	Part no.	A [mm]	B [mm]
<b>E MX wrenches</b>			
E 16 MX	7118.16000	22.5	117
E 20 MX	7118.20000	29	129

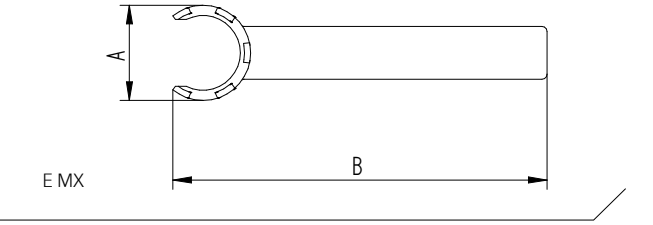

Type	Part no.	A [mm]	B [mm]
<b>A-E AX wrench heads</b>			
A-E 11 AX	7157.11000	16.5	62
A-E 16 AX	7157.16000	22	63
A-E 20 AX	7157.20000	26	64
A-E 25 AX	7157.25000	30	93
A-E 32 AX	7157.32000	37	95
A-E 40 AX	7157.40000	47	99

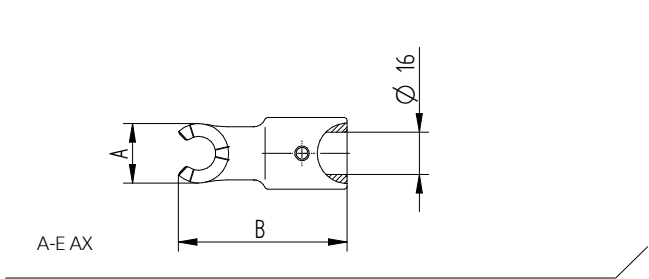

Type	Part no.	A [mm]	B [mm]
<b>A-E MX wrench heads</b>			
A-E 16 MX	7158.16000	22	56
A-E 20 MX	7158.20000	29	68

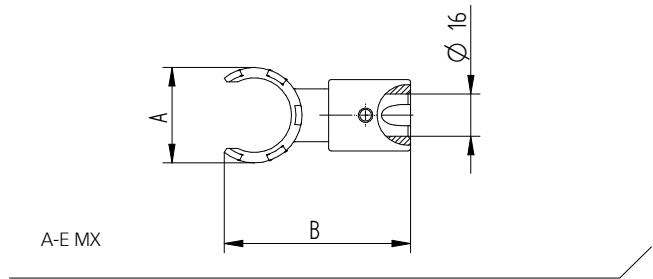

# Torque wrenches TORCO-FIX

## Slip-off proof extensions V-E AX/V-E MX

Type	Part no.	L1 [mm]	Range [Nm]
<b>TORCO-FIX</b>			
TORCO-FIX I	7150.05050	335	10.0–50.0
TORCO-FIX II	7150.20200	465	40.0–200.0

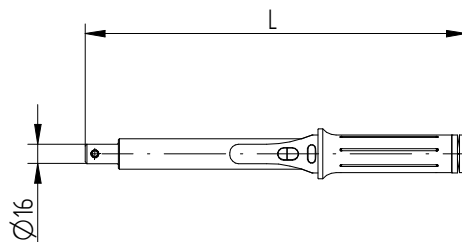

TORCO-FIX

Type	Part no.	D [mm]	L [mm]	Square □	
				[mm]	[inch]
<b>V-E AX extensions</b>					
V-E 11 AX	7155.11000	16.5	60	6.35	¼
V-E 16 AX	7155.16000	22.5	80	6.35	¼
V-E 20 AX	7155.20000	26	95	9.525	¾
V-E 25 AX	7155.25000	29.5	105	12.7	½
V-E 32 AX	7155.32000	37.5	115	12.7	½

Type	Part no.	D [mm]	L [mm]	Square □	
				[mm]	[inch]
<b>V-E MX extensions</b>					
V-E 16 MX	7159.16000	22.5	80	6.35	¼
V-E 20 MX	7159.20000	29	95	12.7	½

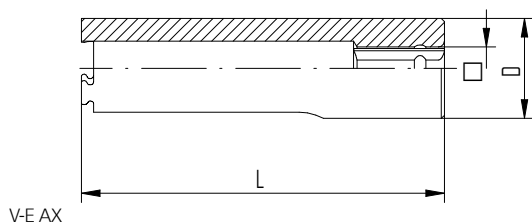

V-E AX

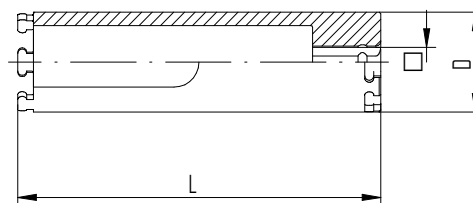

V-E MX

# Technical information

reCool® RCR	reCool® RCS	Shank-Ø [mm]	Recommended tightening torque [Nm]
<b>Recommended tightening torque</b>			
ER 11	–	3.0–6.0	24
ER 16	–	3.0–3.5	20
		4.0–4.5	40
		5.0–10.0	56
ER 20	–	3.0–6.5	32
		7.0–13.0	80
ER 25	–	3.0–3.5	24
		4.0–4.5	56
		5.0–7.5	80
		8.0–17.0	104
ER 32	–	3.0–7.5	136
		8.0–22.0	136
ER 40	–	3.0–26.0	176
ERM 11	–	3.0–3.5	16
ERM 16	ERM 16	3.0–3.5	20
		4.0–10.0	24
ERM 20	ERM 20	3.0–13.0	28
ERM 25	–	3.0–3.5	24
		4.0–17.0	32

## Expert advice

Make sure that coolant flows out of the tool or the coolant flush disk before rotating the reCool® System.

A coolant pressure below minimum may lead to inadequate cooling/lubrication and therefore could damage the reCool® bearings. **Never let the reCool® run dry.**

Inadequate coolant pressure results in considerable impairment in cooling the tool and chip removal.

## reCool® RCR parameters

- // Max. rotation speed: 12,000 rpm (6,000 rpm with ER 40)
- // Min. coolant pressure: depending on the rotational speed (see table for exact pressure)
- // Max. coolant pressure: 150 bar / 2175 PSI\*

## reCool® RCS parameters

- // Min. coolant pressure: 5 bar / 73 PSI
- // Max. coolant pressure: 150 bar / 2175 PSI\*

\* The supplied hose and fittings are designed and tested for maximum coolant pressure of 100 bar / 1450 PSI. For higher coolant pressures the use of the high-pressure hose is mandatory.

Type	Static	≤3,000 rpm	≤6,000 rpm	≤9,000 rpm	≤12,000 rpm
<b>Minimum coolant pressures for working with reCool®</b>					
RCS/ERM 16	5 bar / 73 PSI	–	–	–	–
RCS/ERM 20	5 bar / 73 PSI	–	–	–	–
RCR-E&O/ER 11	–	5 bar / 73 PSI	7.5 bar / 109 PSI	10 bar / 145 PSI	15 bar / 218 PSI
RCR-E&O/ER 16	–	5 bar / 73 PSI	7.5 bar / 109 PSI	10 bar / 145 PSI	15 bar / 218 PSI
RCR-E&O/ER 20	–	5 bar / 73 PSI	7.5 bar / 109 PSI	10 bar / 145 PSI	15 bar / 218 PSI
RCR-E&O/ER 25	–	5 bar / 73 PSI	7.5 bar / 109 PSI	10 bar / 145 PSI	15 bar / 218 PSI
RCR-E&O/ER 32	–	5 bar / 73 PSI	7.5 bar / 109 PSI	10 bar / 145 PSI	15 bar / 218 PSI
RCR-E&O/ER 40	–	5 bar / 73 PSI	7.5 bar / 109 PSI	–	–
RCR/ERM 11	–	5 bar / 73 PSI	7.5 bar / 109 PSI	10 bar / 145 PSI	15 bar / 218 PSI
RCR/ERM 16	–	5 bar / 73 PSI	7.5 bar / 109 PSI	10 bar / 145 PSI	15 bar / 218 PSI
RCR/ERM 20	–	5 bar / 73 PSI	7.5 bar / 109 PSI	10 bar / 145 PSI	15 bar / 218 PSI
RCR/ERM 25	–	5 bar / 73 PSI	7.5 bar / 109 PSI	10 bar / 145 PSI	15 bar / 218 PSI

- // Coolant: Emulsion or oil up to viscosity ≤ ISO VG 46 (46 mm<sup>2</sup>/s 40 °C) and filtered 20 µm
- // Working temperature: 10 °C to 60 °C

# Get in touch

We love to talk to you and share our toolholding expertise to maximize your productivity.



## REGO-FIX AG

Obermattweg 60 / 4456 Tenniken / Switzerland  
P +41 61 976 1466 / F +41 61 976 1414  
rego-fix@rego-fix.ch / [www.rego-fix.com](http://www.rego-fix.com)



### Swiss quality standard

Our products marked Swiss made are manufactured at our headquarters in Tenniken, Switzerland.

REGO-FIX AG is ISO certified:  
ISO 9001 for quality management / since 1996  
ISO 14001 for environmental management / since 2007

This document should not be used or relied on for any purpose other than that intended by REGO-FIX AG. No part of this document may be reproduced or transmitted in any other form without the express written permission of REGO-FIX AG.

© Copyright 2017 REGO-FIX AG

Subsidiaries (distribution companies)

## REGO-FIX Tool Corp.

4420 Anson Blvd / Whitestown / IN 46075 / USA  
P +1 317-870-5959 / F +1 317-870-5955 / [info@rego-fix.com](mailto:info@rego-fix.com)

## REGO-FIX Precision Tools (Shanghai) Co., Ltd.

Room 6301 / Building 6 / No. 338 Jialilue Road  
ZhangJiang Hi-Tech Park / Shanghai / P.R. China 201203  
P +86 21 6160 6933 / F +86 21 6160 6939 / [sales@rego-fix.cn](mailto:sales@rego-fix.cn)

Find your sales partner on [www.rego-fix.com](http://www.rego-fix.com)



0362.00119 RFAG ER reCool 06/17 EN

Your REGO-FIX partner

---

**REGO-FIX AG**  
Obermattweg 60 / 4456 Tenniken / Switzerland  
[www.rego-fix.com](http://www.rego-fix.com)

Subsidiaries (distribution companies)  
**REGO-FIX Tool Corp.**  
Whitestown, IN / USA

**REGO-FIX Precision Tools (Shanghai) Co., Ltd.**  
Shanghai / P.R. China